

» NOVOS 3 x

Room operating unit temperature, optional with humidity | CO2 | VOC

thermokon[®]
HOME OF SENSOR TECHNOLOGY

Datasheet

Subject to technical alteration
Issue date: 11.03.2021 • A114

novos



With design cover (left), standard design w/o design cover (right)

» APPLICATION

Room operating unit with recording room temperature, optional with humidity, CO2 or VOC. The maintenance-free sensor creates the conditions for a pleasant indoor climate and well-being. Typical applications are schools, office buildings, hotels, cinemas or similar.

» TYPES AVAILABLE

Room operating unit – active potentiometer

NOVOS 3 P



NOVOS 3 TD



NOVOS 3 PTD



» NOTES ON DISPOSAL



As a component of a large-scale fixed installation, Thermokon products are intended to be used permanently as part of a building or a structure at a pre-defined and dedicated location, hence the Waste Electrical and Electronic Act (WEEE) is not applicable. However, most of the products may contain valuable materials that should be recycled and not disposed of as domestic waste. Please note the relevant regulations for local disposal.

» SECURITY ADVICE – CAUTION



The installation and assembly of electrical equipment should only be performed by authorized personnel.

The product should only be used for the intended application. Unauthorised modifications are prohibited! The product must not be used in relation with any equipment that in case of a failure may threaten, directly or indirectly, human health or life or result in danger to human beings, animals or assets. Ensure all power is disconnected before installing. Do not connect to live/operating equipment.

Please comply with

- Local laws, health & safety regulations, technical standards and regulations
- Condition of the device at the time of installation, to ensure safe installation
- This data sheet and installation manual

» REMARKS TO ROOM SENSORS

Location and Accuracy of Room Sensors

The room sensor should be mounted in a suitable location for measuring accurate room temperature. The accuracy of the temperature measurement also depends directly on the temperature dynamics of the wall. It is important, that the back plate is completely flush to the wall so that the circulation of air occurs through the vents in the cover. Otherwise, deviations in temperature measurement will occur due to uncontrolled air circulation. Also the temperature sensor should not be covered by furniture or similar devices. Mounting next to doors (due to draught) or windows (due to colder outside wall) should be avoided. The temperature dynamics of the wall will influence the temperature measurement. Various wall types (brick, concrete, dividing and hollow brickwork) all have different behaviours with regards to thermal variations.

Surface and Flush Mounting

The temperature dynamics of the wall influence the measurement result of the sensor. Various wall types (brick, concrete, dividing and hollow brickwork) have different behaviours with regard to thermal variations. A solid concrete wall responds to thermal fluctuations within a room in a much slower way than a light-weight structure wall. Room temperature sensors installed in flush boxes have a longer response time to thermal variations. In extreme cases they detect the radiant heat of the wall even if the air temperature in the room is lower for example. The quicker the dynamics of the wall (temperature acceptance of the wall) or the longer the selected inquiry interval of the temperature sensor is the smaller the deviations limited in time are.

» BUILD-UP OF SELF-HEATING BY ELECTRICAL DISSIPATIVE POWER

Temperature sensors with electronic components always have a dissipative power, which affects the temperature measurement of the ambient air. The dissipation in active temperature sensors shows a linear increase with rising operating voltage. This dissipative power has to be considered when measuring temperature. In case of a fixed operating voltage ($\pm 0,2$ V) this is normally done by adding or reducing a constant offset value. As Thermokon transducers work with a variable operating voltage, only one operating voltage can be taken into consideration, for reasons of production engineering. Transducers 0..10 V / 4..20 mA have a standard setting at an operating voltage of 24 V =. That means, that at this voltage, the expected measuring error of the output signal will be the least. For other operating voltages, the offset error will be increased by a changing power loss of the sensor electronics. If a re-calibration should become necessary later directly on the sensor, this can be done by means of the NOVOSapp software and an optional Bluetooth interface. (additionally with sensors with BUS interface via an appropriate software variable).

Remark: Occurring draft leads to a better carrying-off of dissipative power at the sensor. Thus temporally limited fluctuations might occur upon temperature measurement.

» APPLICATION NOTICE FOR HUMIDITY SENSORS

Refrain from touching the sensitive humidity sensor/element. Touching the sensitive surface will void warranty.

For standard environmental conditions re-calibration is recommended once a year to maintain the specified accuracy.

When exposed to high ambient temperature and/or high levels of humidity or presence of aggressive gases (i.e. chlorine, ozone, ammonia) the sensor element may be affected and re-calibration may be required sooner than specified. Re-calibration and deterioration of the humidity sensor due to environmental conditions are not subject of the general warranty.

» INFORMATION ABOUT SELF-CALIBRATION FEATURE CO2

Virtually all gas sensors are subject to some sort of drift. The degree of drift is partially dependent on the use of quality components and good design. But even with good components and excellent design, a small amount of drift can still occur in the sensor that may ultimately result in the need for a sensor to be recalibrated. The natural drift of the sensor is caused by:

- Dust/dirt
- Aggressive chemicals absorbed inside chamber / optical elements
- Corrosion inside chamber (high rh, condensation)
- Temperature cycles causing mechanical stress
- Electron/hole migration in the photo detector's semiconductor
- Drift of photo amplifiers
- External mechanical stress on chamber
- Light source wear-off

Most of the effects listed above will be compensated by the automatic self-calibration of the sensor's dual channel technology. In contrast to commonly used ABC-Logic self-calibrating sensors with dual channel technology are suitable for all applications including those operating 24 hours, 7 days a week, for example hospitals. However some effects cannot be compensated automatically and may result in a very gradual natural drift of a few ppm per month. This natural drift is not covered by Thermokon's 5-year warranty.

» INFORMATION ABOUT INDOOR AIR QUALITY CO2

EN 13779 defines several classes for indoor air quality:

Category	CO ₂ content above the content in outdoor air in ppm		Description
	Typical range	Standard value	
IDA1	<400 ppm	350 ppm	Good indoor air quality
IDA2	400.. 600 ppm	500 ppm	Standard indoor air quality
IDA3	600..1.000 ppm	800 ppm	Moderate indoor air quality
IDA4	>1.000 ppm	1.200 ppm	Poor indoor air quality

» APPLICATION NOTICE FOR AIR QUALITY SENSORS VOC

Unlike CO₂ sensors, which specifically measure CO₂, mixed gas sensors detect a wide range of gases. The sensor signal does not indicate the type of gas or its concentration in ppm. Mixed gas sensors detect gases and vapours consisting of carbohydrates, or more generally gases that can be oxidised (burnt): Odours, perfume, cleaning fluid scent, tobacco smoke, new materials fumigations (furniture, carpets, paint, glue ...).

Unlike CO₂, which humans cannot sense, the amount of odours (VOC) indicates the level of air quality. VOC sensors have proven their value in a multitude of applications for many years.

Measuring principle:

A heated tin dioxide semiconductor sensor burns (oxidizes) organic molecules that come into contact with it, thereby changing the resistance of the semiconductor. The change in resistance is characteristic for the type and concentration of the molecules. Gas mixtures such as air produce a mixed signal that can not be deduced from individual components. CO₂ can not be detected because it can not be burned.

Refrain from touching the sensor's element sensitive surface. Touching the sensitive surface element will void warranty.

» INFORMATION ABOUT CALIBRATION VOC

Similar to a catalyst, the sensitivity of the sensor decreases over time. The VOC sensor compensates for this decrease in sensitivity through regular auto-calibration.

The measured values are recorded over a period of 24 hours. The lowest value within this period is used as the reference value ("new zero level") for clean, fresh air. Measured thereafter, lower readings result in an immediate adjustment of the reference value.

» TECHNICAL DATA

Measuring values	temperature, optional humidity, CO ₂ , VOC	
Output voltage	TRV VV 3xV 4xV 0..10 V or 0..5 V, min load 10 kΩ (live-zero configuration 1..10/2..10 V via Thermokon NOVOSapp)	
Output Amp	TRA AA 4..20 mA, max. load 500 Ω	
Power supply	TRV VV 3xV 4xV 15..35 V = or 19..29 V ~ SELV	TRA AA 15..35 V = SELV
Power consumption	typ. 0,4 W (24 V =) 0,8 VA (24 V ~)	
Output signal range temp. *scaling analogue output	0..+50 °C (default setting), selectable from 4 temperature ranges -50..+50 0..+50 -15..+35 -20..+80 °C, configurable via NOVOSapp	
Accuracy temperature	±0,5K (typ. at 21 °C)	
Set point (P)	potentiometer, active output 0..10V	
Button (T)	for presence detection, with LED (TD), floating contact, switching capacity max. 0,6 W (24 V=)	
LED (D)	for status feedback, color can be set (from 7 colors) via Jumper, factory default white	
Enclosure	PC V0, pure white, design cover (optional)	
Protection	IP20 according to DIN EN 60529	
Cable entry	Opening rear side, predetermined breaking points on underside, drill mark on top side	
Connection electrical	tool-free mountable spring terminal, max. 1,5 mm ²	
Ambient condition	-20..+70 °C, max. 85% non-condensing, with CO ₂ or VOC sensor operating temperature range 0..+50 °C	
Mounting	surface mounted on flush-mounting box (Ø=60 mm) or to be mounted flat onto the surface using screws, base part can be mounted and wired separately	
Notes	zur Konfiguration ist ein zusätzlicher Programmier-Dongle (Bluetooth) notwendig (siehe Zubehör)	

» Humidity (optional, only for variant NOVOS 3 P TRV/TRA, potentiometer_active)

Measuring range humidity (optional configurable)	relative humidity (default) 0..100% rH configurable via Thermokon NOVOSapp or BUS	Enthalpy 0..85 KJ/kg	absolute humidity 0..50 0..80 g/m ³ ,	dew point 0..+50 -20..+80 °C,
Accuracy humidity	±2% between 10..90% rH (typ. at 21 °C)			

» CO₂ (optional, only for variant NOVOS 3 P TRV/TRA, potentiometer_active)

Measuring range CO ₂	0..2000 ppm 0..5000 ppm (configurable via Thermokon NOVOSapp or BUS)
Accuracy CO ₂	±50 ppm +3 % of reading (typ. at 21 °C, 50% rH, 1015 hPa)
Calibration	self-calibration dual channel
Sensor	NDIR (non-dispersive, infrared)
Display (optional)	RGB-LED indicating air quality (traffic light function 'TLF')

» VOC (optional, only for variant NOVOS 3 P TRV/TRA, potentiometer_active)

Measuring range VOC	0..100 %
Calibration	self-calibration
Sensor	VOC sensor (heated metal oxide semiconductor)

» PRODUCT TESTING AND CERTIFICATION





Declaration of conformity



The declaration of conformity of the products can be found on our website <https://www.thermokon.de/>.

» CONNECTION PLAN

0..5/..10V

NOVOS 3 P TRV, Poti_active <i>additional physical measurand possible*</i>	NOVOS 3 TD TRV	NOVOS 3 PTD TRV, Poti_active
 <ul style="list-style-type: none"> —AOU5— →* —AOU4— →* —AOU3— →* —AOU2— → 0..10V Temperature —AOU1— → 0..10V Poti —GND— ← 0 V⊥ —UB+— ← 15..35V~/19..29V~ 	 <ul style="list-style-type: none"> —D— ← 24V= Diode —T— → 0 V⊥ Button —AOU1— → 0..10V Temperature —GND— ← 0 V⊥ —UB+— ← 15..35V~/19..29V~ 	 <ul style="list-style-type: none"> —D— ← 24V= Diode —T— → 0 V⊥ Button —AOU2— → 0..10V Temperature —AOU1— → 0..10V Poti —GND— ← 0 V⊥ —UB+— ← 15..35V~/19..29V~







4..20mA

NOVOS 3 P TRA, Poti_active <i>other physical measurand possible*</i>	NOVOS 3 TD TRA	NOVOS 3 PTD TRA, Poti_active
 <ul style="list-style-type: none"> —AOI2— → 4..20mA Temperature —AOI1— → 4..20mA Poti —GND— ← 0 V⊥ —UB+— ← 15..35 V= 	 <ul style="list-style-type: none"> —D— ← 24 V= Diode —T— → 0 V⊥ Button —AOI1— → 4..20mA Temperature —GND— ← 0 V⊥ —UB+— ← 15..35 V= 	 <ul style="list-style-type: none"> —D— ← 24 V= Diode —T— → 0 V⊥ Button —AOI2— → 4..20mA Temperature —AOI1— → 4..20mA Poti —GND— ← 0 V⊥ —UB+— ← 15..35 V=



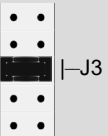

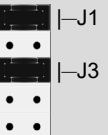
* Connect the variants with the measuring values humidity, CO2 or VOC according to the wiring diagram in the device.

» CONFIGURATION

The jumper setting will select the color of the LED and the control of the button.

Red		Green		Blue	
					
Yellow	Magenta	Turquoise	White		
					

Button terminal assignment

to GND	to UB+
 <ul style="list-style-type: none"> —J4— Button  <ul style="list-style-type: none"> —T— → 0 V⊥ —GND— ← 0 V⊥ 	 <ul style="list-style-type: none"> —J4— Button —J5— Button  <ul style="list-style-type: none"> —T— → UB+ —UB+— ← UB+

» MOUNTING ADVICES

Please make sure that the device is de-energized if you want to install it!

The installation can be performed on the flat wall surface or on a flush-mounted box. A representative place should be selected. Sunshine and draft, e.g. in the installation tube should be avoided, so that the measurement result is not falsified. Seal the end of the installation tube.

- For wiring, the upper part of the device must be removed from the base plate. Base plate and upper part are detachably connected to each other by means of locking lugs.
- The mounting of the base plate on the flat wall surface is done with rawplugs and screws.
- Finally, the device is attached to the base plate and fixed with the screw.

Housing open / close

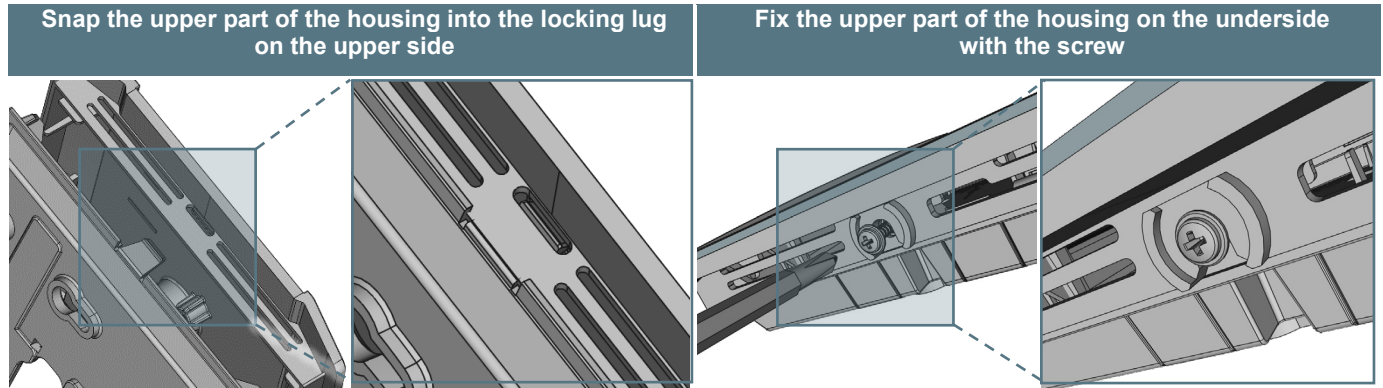

Cable entry

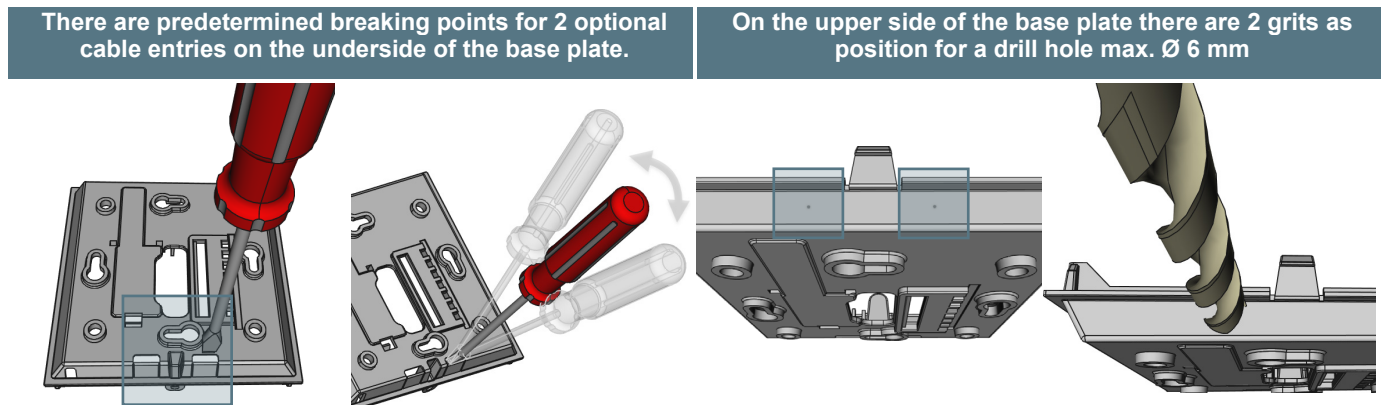

When using a drill, you should absolutely ensure that the base plate is firmly clamped. Before drilling, the pressure must be reduced and carefully drilled. A sudden break-through of the drill bit can be the result.

» CONFIGURATION

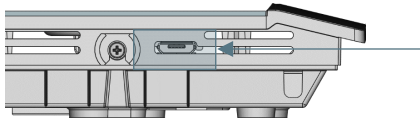

Position of the micro USB port, see bottom of the device, for configuration with Bluetooth dongle or Micro-USB programming interface

The configuration is performed in powered state. The following options are available for configuring the device:

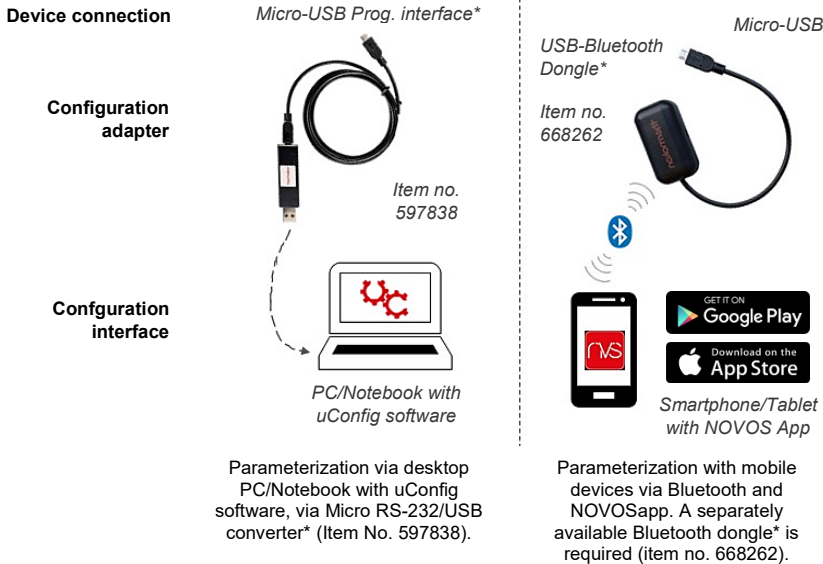

*Commercially available Bluetooth dongles or USB to Micro-USB adapter cables are not compatible. You need a mobile device that supports at least Bluetooth version 4.1. The configuration app with the corresponding instructions can be downloaded from the Google Play Store or the Apple App Store.

» DIMENSIONS (MM)

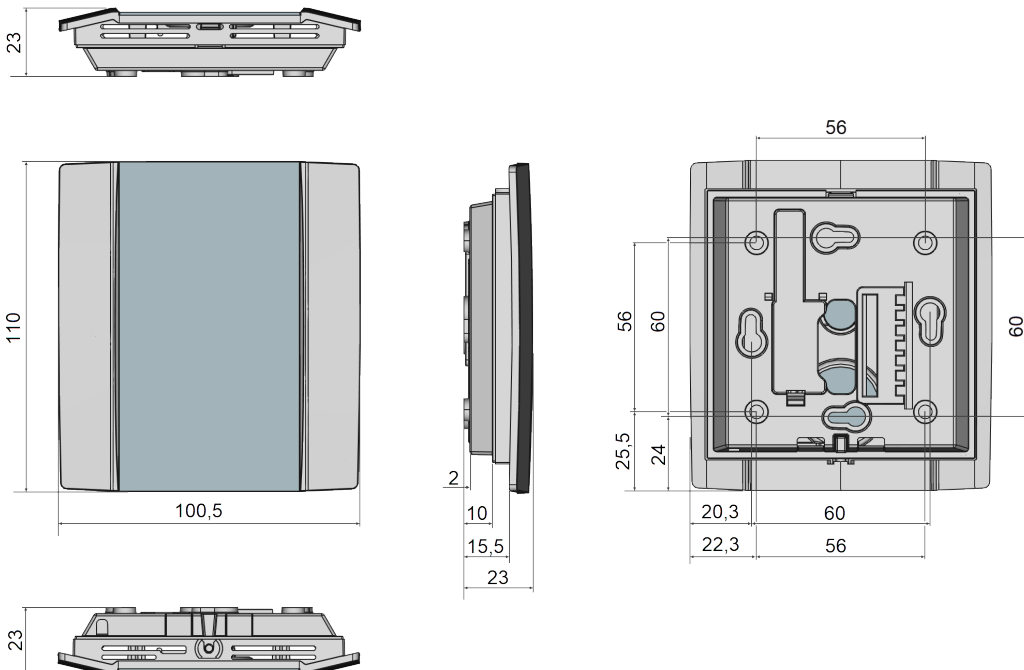

» ACCESSORIES (OPTIONAL)

- Rawplugs and screws (2 pcs. each)
- Ball stroke protection BS150
- Bluetooth dongle
- PSU-UP24 – flush mount power supply 24 V (AC Input: 100..240 V ~ | DC Output 24 V = 0,5 A)
- Programming interface, USB – Micro-USB

- Item No. 102209
- Item No. 647007
- Item No. 668262
- Item No. 645737
- Item No. 597838